

Transportwagen



DE Bedienungsanleitung
EN Instructions for use
FR Instruction d'utilisation
ES Instrucciones de uso
IT Istruzioni d'uso
NL Gebruiksaanwijzing
DA Brugsanvisning
FI Käyttöohje
PL Instrukcja obsługi

CZ Návod k používání
TR Kullanım kilavuzu
HU Kezelési útmutató
BG Инструкция за експлоатация
RO Manualul de utilizare
ET Kasutusjuhend läbi
LT Naudojimo instrukcija
LV Lietošanas pamācība
EL Οδηγίες χρήσεως



A Overview

no. 56051

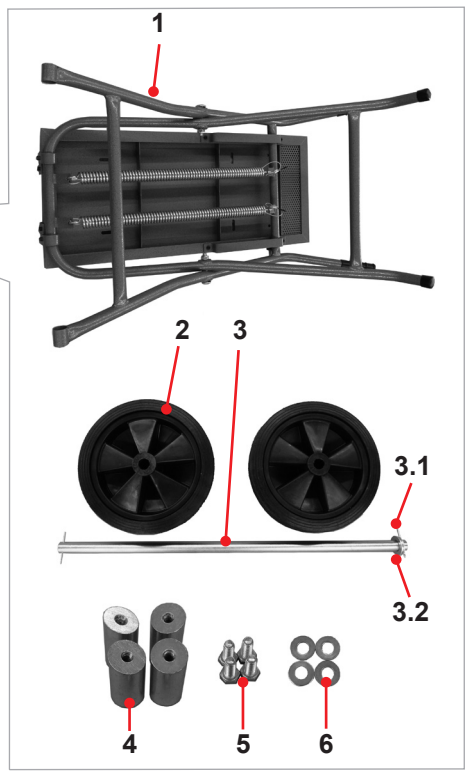

i Transport:

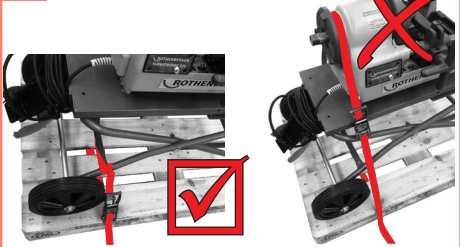

B Footswitchholder

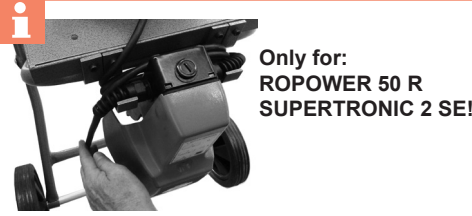

Preparing for threader C

1

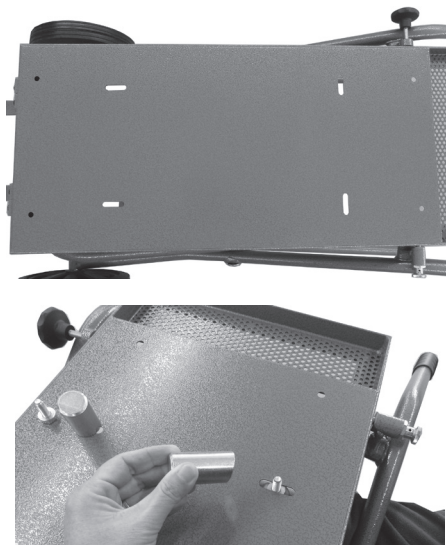

2

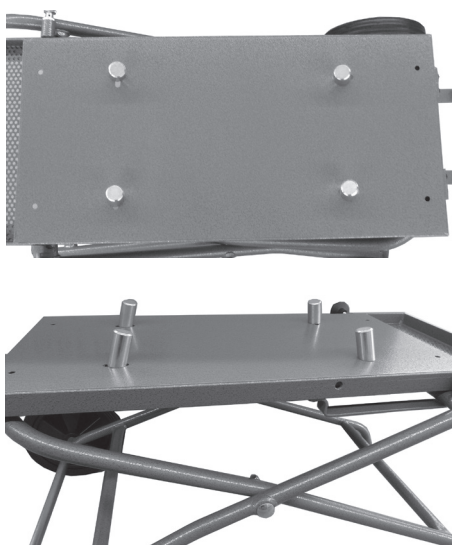

Raising threader stand D

1

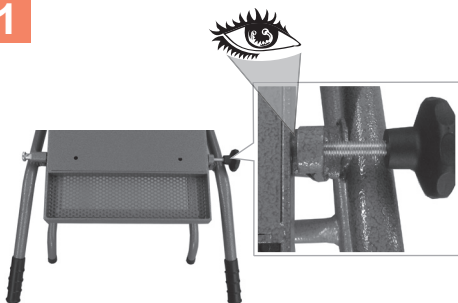

3

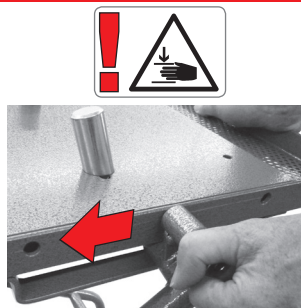

2

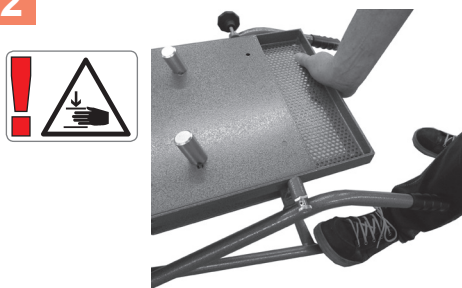

4

